



Applications

- Coves
- Furniture
- Back-lighting
- Hospitality
- Retail
- Office
- Residential

Features

- IP54
- 3 step MacAdam
- Small PCB cut increments of 50mm up to 2000mm
- A range of 2200K - 5700K
- 130 lumens per Watt
- CRI >80 - >90
- Luxeon LED
- 120° beam angle as standard
- 22W and 17W (24V)
- Sleek family of Aluminium profiles with Clear and Opal diffusers
- LM80 Lifetime 50,000 hrs
- Dimmable via DALI, DMX, Bluetooth
- ECO friendly and Energy Saving
- Fixed or Adjustable Bracket

Benefits

- Improved colour consistency across large and small projects
- Greater flexibility to produce a large range of lengths.
- High lumen output
- Excellent Colour Rendering
- Highest quality Luxeon LEDs
- Excellent lumen maintenance over lifetime
- Reduced potential failure during handling with ESD protection
- ROHS compliant

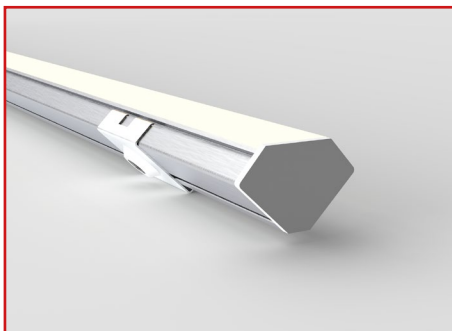

PRO-SXL-DW

Technical Information

Product Specification	High Power	Medium Power
Lumen Output (lm/m) based on 4000K	2880	2282
Power per Colour Channel (W/m)	22W	17W
Efficacy lm/W (based on 4000K)	130lm/W	132lm/W
Input Voltage (V)	24V	
Colour Range	2200K - 5700K	
CRI	>80 - >90	
LED Chip	Luxeon	
Binning	3 Step MacAdam	
Control	DMX - DALI - Bluetooth	
Beam Angles	Opal Diffused - 120°	
Lifetime @ LM80	50,000hrs @ 25°C	
Operating Temp	- 25°C to 55°C	
IP Rating	IP54	
Cover/Lens	Clear - Opal	
Finish	Anodised Aluminium	
Mounting	Fixed or Adjustable Brackets	
Connection	300mm Cable to Connector	
Lengths	74mm - 2024mm	

Technical Information

High Power - 4000K - Clear

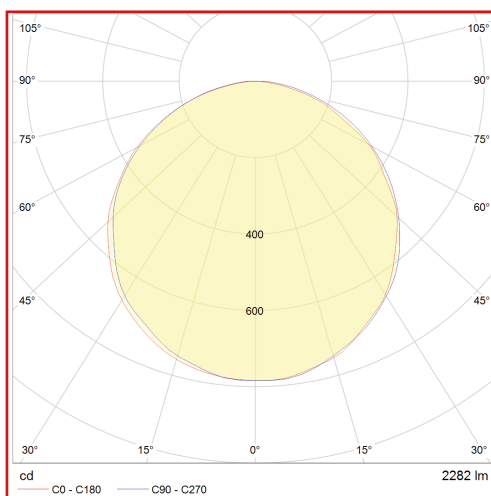

High Power - 4000K - Opal

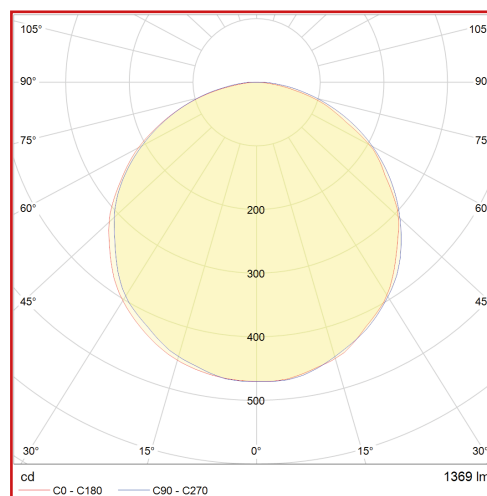

PRO-SXL-DW

Product Selector

PRO-SXL-DW-22-22-57-80-O-54-F

Power

22W **22**
 17W **17**

Colour

2200K **22**
 2500K **25**
 2700K **27**
 3000K **30**
 3500K **35**
 4000K **40**
 5000K **50**
 5700K **57**

Colour

2200K **22**
 2500K **25**
 2700K **27**
 3000K **30**
 3500K **35**
 4000K **40**
 5000K **50**
 5700K **57**

CRI

>80 **80**
 >90 **90**

Diffuser

Clear (120°) **C**
 Opal **O**

IP Rating

IP54 **54**

Mounting Brackets

Fixed **F**
 Adjustable **A**

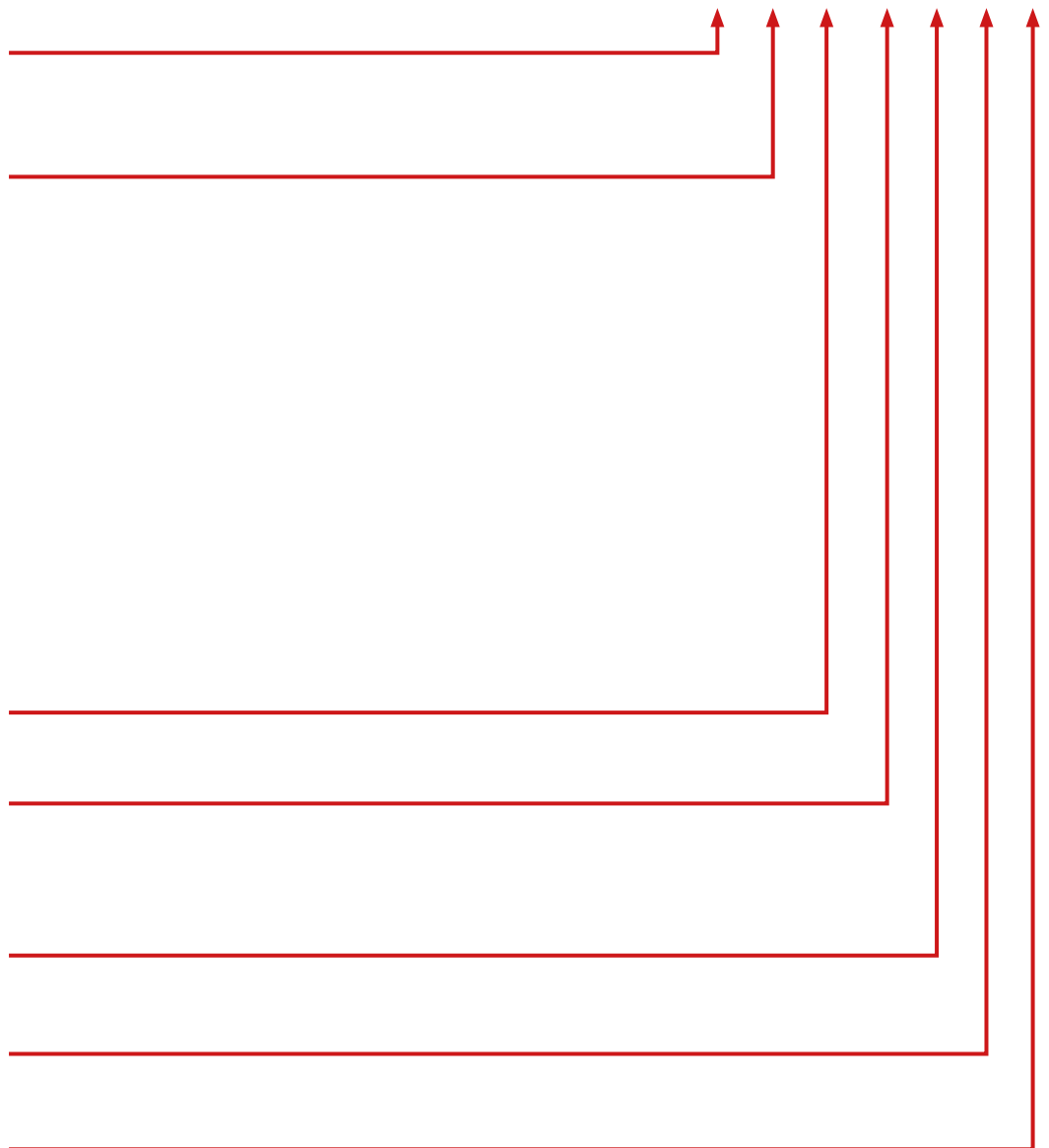

Please contact our sales team to discuss your requirements.

PRO-SXL-DW



Specification Drawings

Standard Cable Entry
300mm Tail

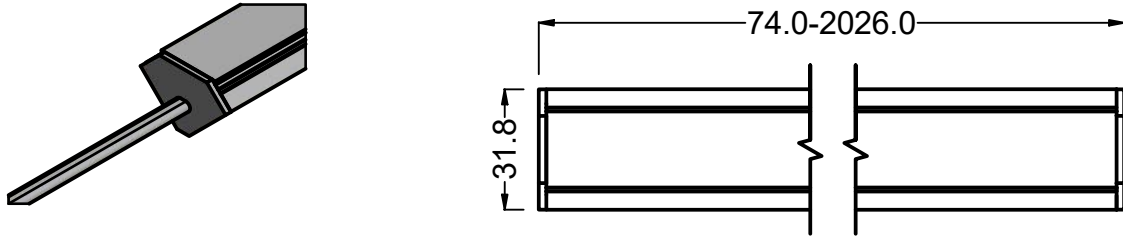

Flat Diffuser

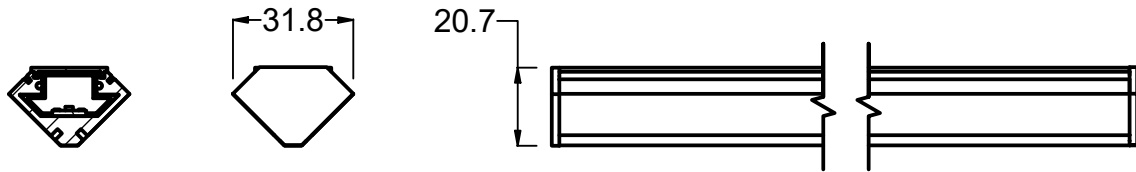

Adjustable Bracket

Surface Mount Clip

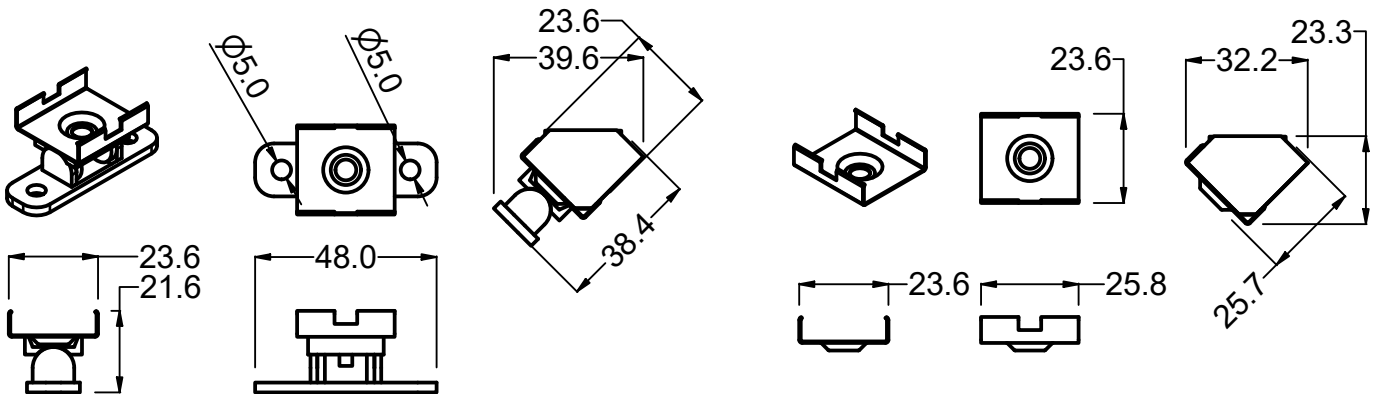

Installation Warning

The maximum combined output when using both colour channels should not exceed 17W or 22W. This can cause catastrophic failure and void warranty.

Complies with EN60598-1 and pertinent regulations



Please contact our sales team on **+44(0)113 263 9039** for further assistance

Specifications are subject to change without prior notice. Please refer to our website for most up to date version

