

# Figaro 40 L S

## Surface Mounted Louvre

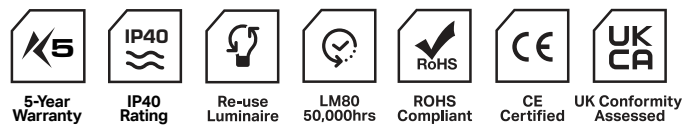

### Features

- LED surface mounted luminaire, direct light distribution.
- Highly efficient lighting system for offices, education & retail environment.
- <19 UGR - over 145 lumens per circuit watt (BREEAM regs).
- Unique Dark Light metal specular gloss louvres to minimise glare and maximise efficiency.
- Options for Black or White louvres in Matt or Gloss finish.
- 35°- 50°- 80°- 80°Batwing & Wall wash optics available.
- CCT 3000K, 4000K, others available on request (subject to quantity).
- Latest Tridonic LED technology with CRI80 & 90 as standard.
- Aluminium body - sleek lightweight design, 45mm width x 82mm height.
- Choice of silver, black and white body colours as standard with many custom RAL colours available.
- Various lengths from 567mm > 2807mm as standard.
- Integral gear.

### Applications

- Retail
- Hospitality
- Educational
- Commercial
- Public Realm

### Product Options

<b>Control</b>	Switched • DALI 2 • (0)1-10V • Bluetooth (Casambi)
<b>CCT</b>	3000K • 4000K
<b>CRI</b>	>90CRI • >80CRI
<b>Body Colour</b>	Black • White • Silver Custom RAL on request.
<b>Emergency*</b>	Available on Lengths above 1407

### Technical Information

Length	CRI	3000K						4000K					
		LOW			HIGH			LOW			HIGH		
		Fitting Lumens	Fitting Watts	Lum/W	Fitting Lumens	Fitting Watts	Lum/W	Fitting Lumens	Fitting Watts	Lum/W	Fitting Lumens	Fitting Watts	Lum/W
567	80	850	6.2	137	1682	12.7	132	889	6.2	144	1760	12.7	139
	90	742	6.2	120	1459	12.7	115	774	6.2	125	1524	12.7	120
847	80	1277	9.3	137	2523	19.1	132	1336	9.3	144	2640	19.1	139
	90	1113	9.3	120	2190	19.1	115	1161	9.3	125	2286	19.1	120
1127	80	1699	12.4	137	3364	25.4	132	1778	12.4	144	3521	25.4	139
	90	1484	12.4	120	2919	25.4	115	1548	12.4	125	3048	25.4	120
1407	80	2127	15.5	137	4205	31.8	132	2226	15.5	144	4401	31.8	139
	90	1855	15.5	120	3649	31.8	115	1935	15.5	125	3810	31.8	120
1967	80	2976	21.7	137	5888	44.5	132	3115	21.7	144	6161	44.5	139
	90	2597	21.7	120	5108	44.5	115	2709	21.7	125	5334	44.5	120
2247	80	3404	24.8	137	6729	50.8	132	3562	24.8	144	7041	50.8	139
	90	2968	24.8	120	5839	50.8	115	3096	24.8	125	6096	50.8	120
2527	80	3826	27.9	137	7570	57.2	132	4004	27.9	144	7921	57.2	139
	90	3339	27.9	120	6568	57.2	115	3483	27.9	125	6858	57.2	120
2807	80	4254	31.0	137	8411	63.5	132	4451	31.0	144	8801	63.5	139
	90	3710	31.0	120	7298	63.5	115	3870	31.0	125	7620	63.5	120

Based on Black Matt Reflector

Length	CRI	3000K						4000K					
		LOW			HIGH			LOW			HIGH		
		Fitting Lumens	Fitting Watts	Lum/W	Fitting Lumens	Fitting Watts	Lum/W	Fitting Lumens	Fitting Watts	Lum/W	Fitting Lumens	Fitting Watts	Lum/W
567	80	948	6.2	153	1878	12.7	148	993	6.2	160	1965	12.7	155
	90	828	6.2	134	1629	12.7	128	864	6.2	139	1701	12.7	134
847	80	1426	9.3	153	2817	19.1	148	1492	9.3	160	2947	19.1	155
	90	1242	9.3	133	2444	19.1	128	1296	9.3	139	2552	19.1	134
1127	80	1897	12.4	153	3756	25.4	148	1985	12.4	160	3930	25.4	155
	90	1657	12.4	134	3258	25.4	128	1728	12.4	139	3402	25.4	134
1407	80	2374	15.5	153	4694	31.8	148	2484	15.5	160	4912	31.8	155
	90	2071	15.5	133	4073	31.8	128	2160	15.5	139	4253	31.8	134
1967	80	3323	21.7	153	6572	44.5	148	3477	21.7	160	6877	44.5	155
	90	2899	21.7	133	5702	44.5	128	3024	21.7	139	5954	44.5	134
2247	80	3800	24.8	153	7511	50.8	148	3976	24.8	160	7860	50.8	155
	90	3313	24.8	133	6517	50.8	128	3456	24.8	139	6804	50.8	134
2527	80	4271	27.9	153	8450	57.2	148	4470	27.9	160	8843	57.2	155
	90	3728	27.9	133	7332	57.2	128	3888	27.9	139	7655	57.2	134
2807	80	4748	31.0	153	9389	63.5	148	4969	31.0	160	9825	63.5	155
	90	4141	31.0	133	8147	63.5	128	4320	31.0	139	8506	63.5	134

Based on Specular Matt Reflector (Dark Light)

## Product Code

**FIG40-L-S-1-2-3-4-5-6-7** *Example Codes*

Create your product code by choosing your specification from the product areas.

**FIG40-L-S-H-830-D-35-MB-9005-XXXX**  
**FIG40-L-S-L-940-B-80-GW-9003-XXXX**

Final example codes are shown to the right.

<b>1</b> Drive Current	<b>2</b> CCT	<b>3</b> Control	<b>4</b> Beam Angle	
High	<b>H</b> 80 CRI - 3000K	<b>830</b> Switched	<b>S</b> 35° <b>35</b>	
Low	<b>L</b> 80 CRI - 4000K	<b>840</b> DALI	<b>D</b> 50° <b>50</b>	
	90 CRI - 3000K	<b>930</b> 0-10V	<b>O</b> 80° <b>80</b>	
	90 CRI - 4000K	<b>940</b> Bluetooth Casambi	<b>B</b> 80° Batwing	<b>80B</b>
			Wall Wash	<b>WW</b>
			Asymmetric	<b>ASY</b>

  

<b>5</b> Reflector	<b>6</b> Finish	<b>7</b> Length*	Extras - On Request**
Matt White	<b>MW</b> Jet Black	<b>9005</b> XXXXmm	<b>XXXX</b> Emergency Module Motion sensor
Gloss White	<b>GW</b> Signal White	<b>9003</b>	
Matt Black	<b>MB</b> White Aluminium	<b>9006</b>	
Gloss Black	<b>GB</b> Custom RAL**	<b>RAL#</b>	
Specular Matt (Dark Light)	<b>SM</b>		
Specular Gloss (Dark Light)	<b>SG</b>		

\*Custom lengths, infills and continuous runs available. \*\* Custom RAL colours subject to availability and order size

\*\*\*Please enquire with your requirements.

# Technical Drawings

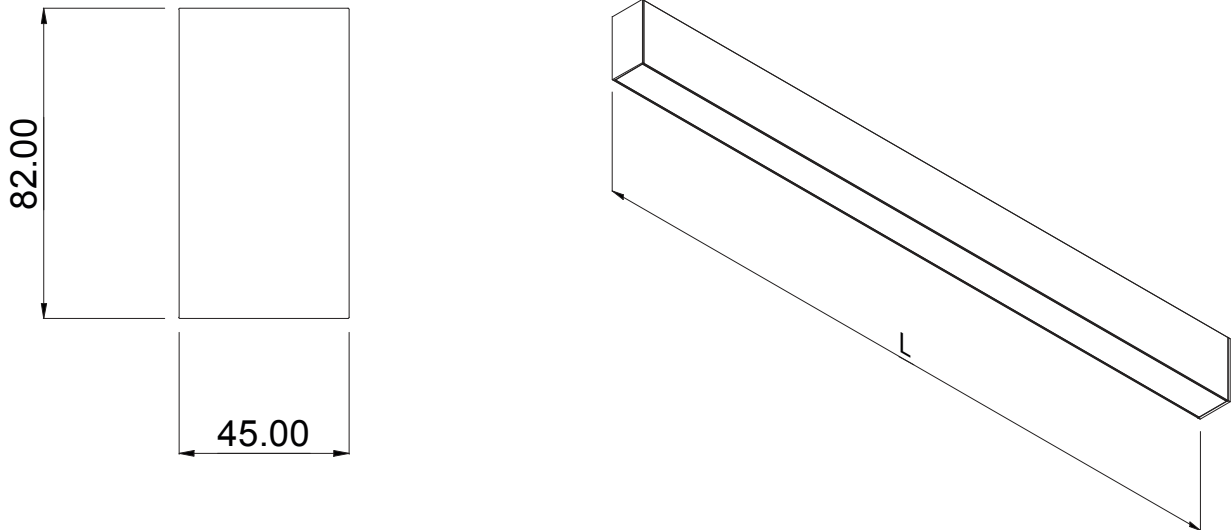

## Additional Accessories

3D printed ceiling rose 125mm dia (RAL colour on request) - CR001

## Beam Angle Variations

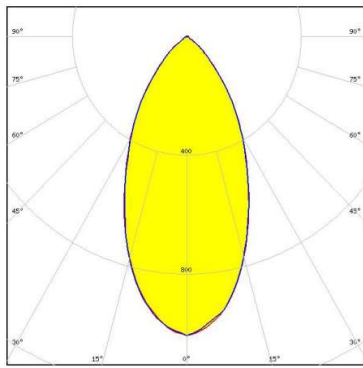

35°

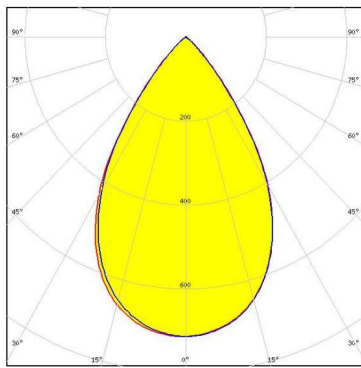

50°

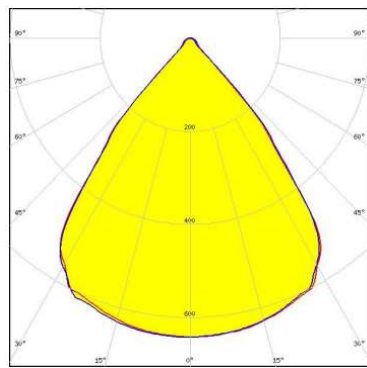

80°

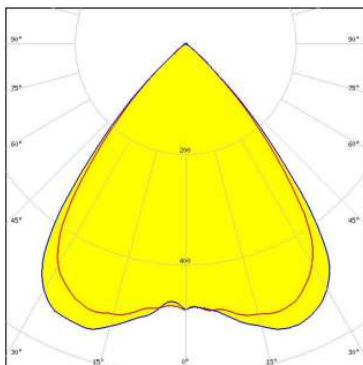

80° Batwing

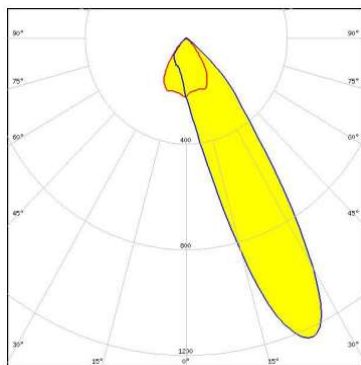

Asymmetric  
(Aisle Lighting)

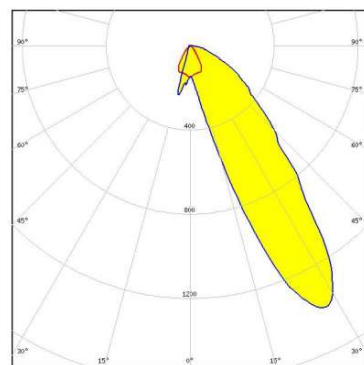

Asymmetric  
(Wall-washing)

FIG40-L-S-1122

Complies with EN60598-1 and pertinent regulations

Specifications are subject to change without prior notice. Please refer to our website for most up to date version.



Contact our sales team for further assistance

0113 2639039 <sup>N</sup> sales@kempslighting.com kemparchitectorallighting.com

